

Flat-pack Indoor Cabinet Datasheet



Fushan Europe
Precision Manufacturing & Integration

FE_IC_201702002

Flat-pack Indoor Cabinets

F-type network rack cabinet system offers the best solution for IT and Telecom applications in dense and complex cabling environments. A wide range of cable management accessories is available to ensure perfect management of copper & fiber cables and 19" equipment. Vertical 19" mounting rails can be adjusted freely through the depth, which simplifies mounting of any device and configuration of connecting cables. Flat-pack option enables savings up to 60% in the transport cost and warehouse space.



Technical Features

Material	Frame: electrostatic powder-painted steel extrusion profiles Other parts: 1.2mm and 1.5mm cold rolled steel
Finish	Doors, side panels, top covers: electrostatic powder paint
Color	RAL 7035 or RAL 9005
Maximum static load	Up to 2000 kg
Compliance	RoHS, UL Certified
Packaging	Assembled or unassembled
Accessories	19" mounting rails cable organizer blanking panels cable channels

Standard Configuration

- Perforated curved front door
- Double perforated flat rear door
- Multifunction cable management board
- 2 pairs of depth adjustable heavy duty 19" mounting rails
- 2 pairs of adjustable feet
- Front door with swing-handle single point lock
- Color RAL 7035 or RAL 9005
- Safety report (Low Voltage Directive) and RoHS compliance statement for rack and accessories



Dimensions and ordering information

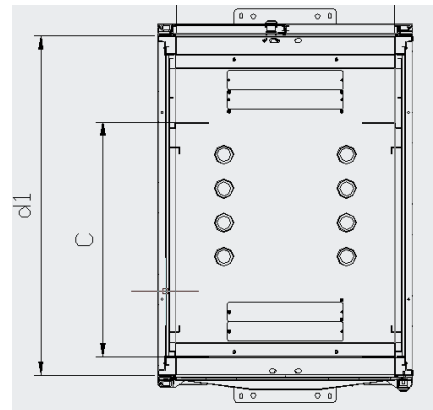
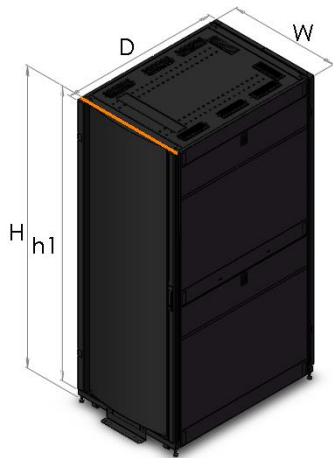

Height U	Outer Width (W) mm	Outer Depth (D) mm	Outer Height (H) mm	Frame Depth (d1) mm	Frame Height (h1) mm	19" Rails Adjustable Depth Range (c)	Part No
26U	600	670	1288.8	600	1243.8	180-360	LW-FS-2666A
26U	600	870	1288.8	800	1243.8	180-460	LW-FS-2668A
26U	600	1070	1288.8	1000	1243.8	180-660	LW-FS-26610A
26U	600	1270	1288.8	1200	1243.8	180-800	LW-FS-26612A
26U	800	870	1288.8	800	1243.8	180-460	LW-FS-2688A
26U	800	1070	1288.8	1000	1243.8	180-660	LW-FS-26810A
26U	800	1270	1288.8	1200	1243.8	180-800	LW-FS-26812A
32U	600	670	1555.5	600	1510.5	180-360	LW-FS-3266A
32U	600	870	1555.5	800	1510.5	180-460	LW-FS-3268A
32U	600	1070	1555.5	1000	1510.5	180-660	LW-FS-32610A
32U	600	1270	1555.5	1200	1510.5	180-800	LW-FS-32612A
32U	800	870	1555.5	800	1510.5	180-460	LW-FS-3288A
32U	800	1070	1555.5	1000	1510.5	180-660	LW-FS-32810A
32U	800	1270	1555.5	1200	1510.5	180-800	LW-FS-32812A
36U	600	670	1733.3	600	1688.3	180-360	LW-FS-3666A
36U	600	870	1733.3	800	1688.3	180-460	LW-FS-3668A
36U	600	1070	1733.3	1000	1688.3	180-660	LW-FS-36610A
36U	600	1270	1733.3	1200	1688.3	180-800	LW-FS-36612A
36U	800	870	1733.3	800	1688.3	180-460	LW-FS-3688A
36U	800	1070	1733.3	1000	1688.3	180-660	LW-FS-36810A
36U	800	1270	1733.3	1200	1688.3	180-800	LW-FS-36812A
38U	600	670	1822.2	600	1777.2	180-360	LW-FS-3866A
38U	600	870	1822.2	800	1777.2	180-460	LW-FS-3868A
38U	600	1070	1822.2	1000	1777.2	180-660	LW-FS-38610A
38U	600	1270	1822.2	1200	1777.2	180-800	LW-FS-38612A
38U	800	870	1822.2	800	1777.2	180-460	LW-FS-3888A
38U	800	1070	1822.2	1000	1777.2	180-660	LW-FS-38810A
38U	800	1270	1822.2	1200	1777.2	180-800	LW-FS-38812A
42U	600	670	2000	600	1955	180-360	LW-FS-4266A
42U	600	870	2000	800	1955	180-460	LW-FS-4268A
42U	600	1070	2000	1000	1955	180-660	LW-FS-42610A
42U	600	1270	2000	1200	1955	180-800	LW-FS-42612A
42U	800	870	2000	800	1955	180-460	LW-FS-4288A
42U	800	1070	2000	1000	1955	180-660	LW-FS-42810A
42U	800	1270	2000	1200	1955	180-800	LW-FS-42812A
42U	750	1070	2000	1000	1955	180-660	LW-FS-427510A
48U	600	670	2266.7	600	2221.7	180-360	LW-FS-4866A
48U	600	870	2266.7	800	2221.7	180-460	LW-FS-4868A
48U	600	1070	2266.7	1000	2221.7	180-660	LW-FS-48610A
48U	600	1270	2266.7	1200	2221.7	180-800	LW-FS-48612A
48U	800	870	2266.7	800	2221.7	180-460	LW-FS-4888A
48U	800	1070	2266.7	1000	2221.7	180-660	LW-FS-48810A
48U	800	1270	2266.7	1200	2221.7	180-800	LW-FS-48812A

Color code: Light Grey (RAL 7035) – Black (RAL 9005)

Components of Flat-pack Cabinet

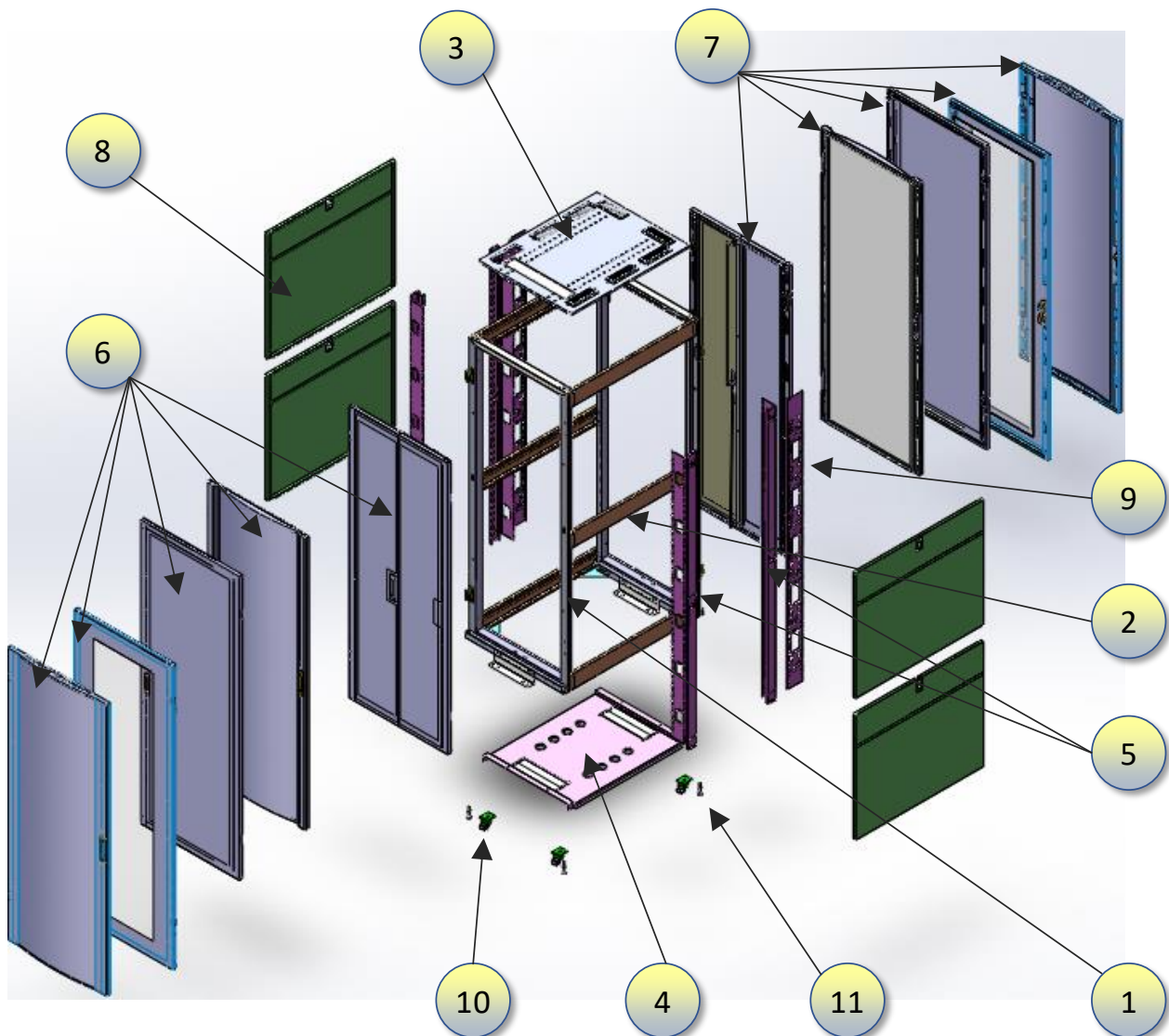

1 – Steel frame

2 – Side support rail

3 – Top cover

4 – Bottom sheet

5 – 19" mounting rails

6 – Front door options

7 – Rear door options

8 – Side panels

9 – Multifunction cable management board

10 – Castor

11 – Adjustable feet

Frame

Material: 2mm steel **Finish:** Electrostatic powder paint
Colors: RAL 7035 and RAL 9005

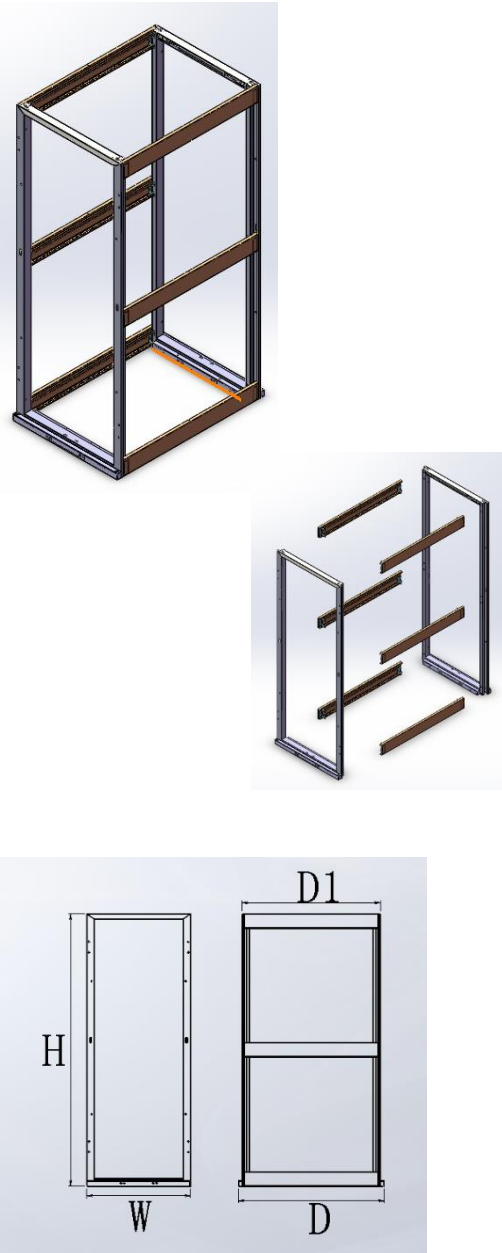

Height (U)	H (mm)	W (mm)	D (mm)	D1 (mm)	Part No
26U	1243.8	600	655	600	LW-FS-2666-01
26U	1243.8	600	855	800	LW-FS-2668-01
26U	1243.8	600	1055	1000	LW-FS-26610-01
26U	1243.8	600	1255	1200	LW-FS-26612-01
26U	1243.8	800	855	800	LW-FS-2688-01
26U	1243.8	800	1055	1000	LW-FS-26810-01
26U	1243.8	800	1255	1200	LW-FS-26812-01
32U	1510.5	600	655	600	LW-FS-3266-01
32U	1510.5	600	855	800	LW-FS-3268-01
32U	1510.5	600	1055	1000	LW-FS-32610-01
32U	1510.5	600	1255	1200	LW-FS-32612-01
32U	1510.5	800	855	800	LW-FS-3288-01
32U	1510.5	800	1055	1000	LW-FS-32810-01
32U	1510.5	800	1255	1200	LW-FS-32812-01
36U	1688.3	600	655	600	LW-FS-3666-01
36U	1688.3	600	855	800	LW-FS-3668-01
36U	1688.3	600	1055	1000	LW-FS-36610-01
36U	1688.3	600	1255	1200	LW-FS-36612-01
36U	1688.3	800	855	800	LW-FS-3688-01
36U	1688.3	800	1055	1000	LW-FS-36810-01
36U	1688.3	800	1255	1200	LW-FS-36812-01
38U	1777.2	600	655	600	LW-FS-3866-01
38U	1777.2	600	855	800	LW-FS-3868-01
38U	1777.2	600	1055	1000	LW-FS-38610-01
38U	1777.2	600	1255	1200	LW-FS-38612-01
38U	1777.2	800	855	800	LW-FS-3888-01
38U	1777.2	800	1055	1000	LW-FS-38810-01
38U	1777.2	800	1255	1200	LW-FS-38812-01
42U	1955	600	655	600	LW-FS-4266-01
42U	1955	600	855	800	LW-FS-4268-01
42U	1955	600	1055	1000	LW-FS-42610-01
42U	1955	600	1255	1200	LW-FS-42612-01
42U	1955	800	855	800	LW-FS-4288-01
42U	1955	800	1055	1000	LW-FS-42810-01
42U	1955	800	1255	1200	LW-FS-42812-01
42U	1955	750	1055	1000	LW-FS-427510-01
48U	2221.7	600	655	600	LW-FS-4866-01
48U	2221.7	600	855	800	LW-FS-4868-01
48U	2221.7	600	1055	1000	LW-FS-48610-01
48U	2221.7	600	1255	1200	LW-FS-48612-01
48U	2221.7	800	855	800	LW-FS-4888-01
48U	2221.7	800	1055	1000	LW-FS-48810-01
48U	2221.7	800	1255	1200	LW-FS-48812-01

Top Cover

Material: 1.5mm steel **Finish:** Electrostatic powder paint
Colors: RAL 7035 and RAL 9005

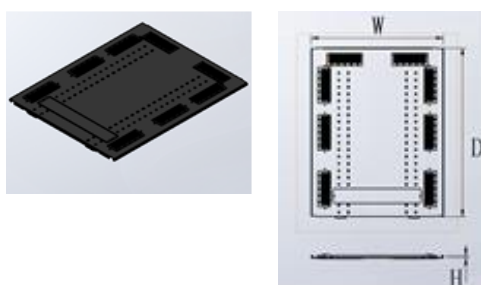

Cabinet Outer Depth	Cabinet Outer Width	H (mm)	D (mm)	W (mm)	Part No
670	600	12.5	497	552	LW-FS-66-02
870	600	12.5	697	552	LW-FS-68-02
1070	600	12.5	897	552	LW-FS-610-02
1270	600	12.5	1097	552	LW-FS-612-02
870	800	12.5	697	752	LW-FS-88-02
1070	800	12.5	897	752	LW-FS-810-02
1270	800	12.5	1097	752	LW-FS-812-02
1070	750	12.5	897	702	LW-FS-7510-02

Side Support Rails

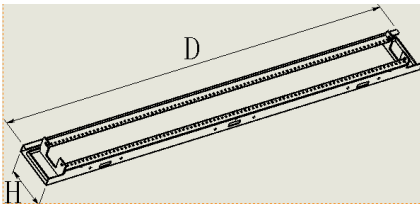
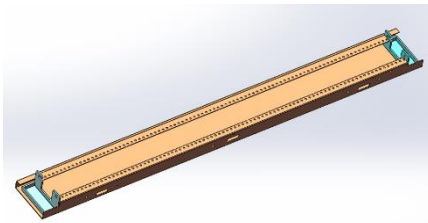

Material: 1.5mm steel **Finish:** Electrostatic powder paint
Colors: RAL 7035 and RAL 9005

Cabinet Outer Depth	D (mm)	H (mm)	Part No
670	497	12,5	LW-FS-600-04
870	697	12,5	LW-FS-800-04
1070	897	12,5	LW-FS-1000-04
1270	1097	12,5	LW-FS-1200-04

Bottom Sheet

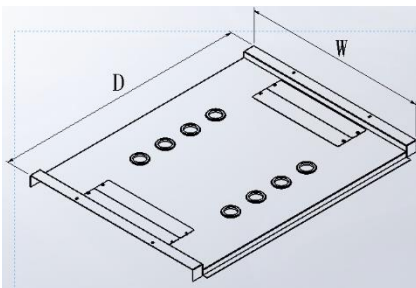
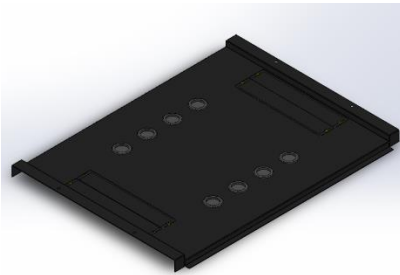

Material: 1.5mm steel **Finish:** Electrostatic powder paint
Colors: RAL 7035 and RAL 9005

Cabinet Outer Depth	Cabinet Outer Width	D (mm)	W (mm)	Part No
670	600	485	495	LW-FS-66-03
870	600	685	495	LW-FS-68-03
1070	600	885	495	LW-FS-610-03
1270	600	1085	495	LW-FS-612-03
870	800	685	695	LW-FS-88-03
1070	800	885	695	LW-FS-810-03
1270	800	1085	695	LW-FS-812-03
1070	750	885	695	LW-FS-7510-03

19" Mounting Rails



Material: 2mm steel **Finish:** Electrostatic powder paint
Colors: RAL 7035 and RAL 9005

Height (U)	H (mm)	D (mm)	W (mm)	Part No
26U	1219,2	92	42	LW-FS-26U-05
32U	1485,9	92	42	LW-FS-32U-05
36U	1663,7	92	42	LW-FS-36U-05
38U	1752,2	92	42	LW-FS-38U-05
42U	1930,0	92	42	LW-FS-42U-05
48U	2196,7	92	42	LW-FS-48U-05

Side Panel

Material: 1.2mm steel **Finish:** Electrostatic powder paint
Colors: RAL 7035 and RAL 9005

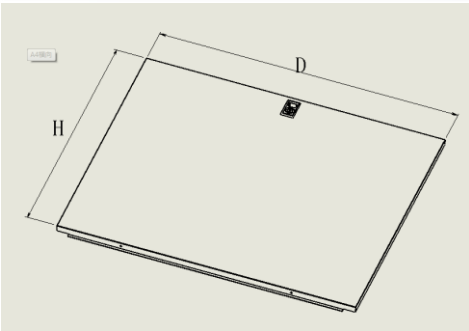
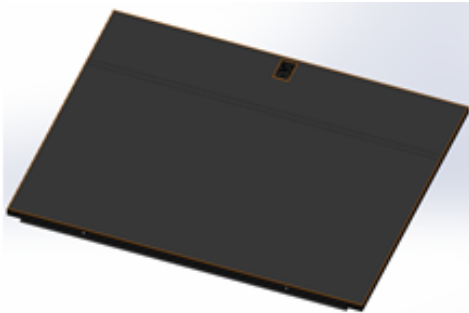

Height (U)	Cabinet Outer Depth	H (mm)	D (mm)	Part No
26U	670	298,8	565,5	LW-FS-26U6-06
26U	870	298,8	765,5	LW-FS-26U8-06
26U	1070	298,8	965,5	LW-FS-26U10-06
26U	1270	298,8	1165,5	LW-FS-26U12-06
32U	670	432,15	565,5	LW-FS-32U6-06
32U	870	432,15	765,5	LW-FS-32U8-06
32U	1070	432,15	965,5	LW-FS-32U10-06
32U	1270	432,15	1165,5	LW-FS-32U12-06
36U	670	521,05	565,5	LW-FS-36U6-06
36U	870	521,05	765,5	LW-FS-36U8-06
36U	1070	521,05	965,5	LW-FS-36U10-06
36U	1270	521,05	1165,5	LW-FS-36U12-06
38U	670	732,6	565,5	LW-FS-38U6-06
38U	870	732,6	765,5	LW-FS-38U8-06
38U	1070	732,6	965,5	LW-FS-38U10-06
38U	1270	732,6	1165,5	LW-FS-38U12-06
42U	670	821,5	565,5	LW-FS-42U6-06
42U	870	821,5	765,5	LW-FS-42U8-06
42U	1070	821,5	965,5	LW-FS-42U10-06
42U	1270	821,5	1165,5	LW-FS-42U12-06
48U	670	954,8	565,5	LW-FS-48U6-06
48U	870	954,8	765,5	LW-FS-48U8-06
48U	1070	954,8	965,5	LW-FS-48U10-06
48U	1270	954,8	1165,5	LW-FS-48U12-06

Multifunction Cable Management Board

Material: 1.5mm steel **Finish:** Electrostatic powder paint
Colors: RAL 7035 and RAL 9005



Height (U)	H (mm)	W (mm)	Part No
26U	1219,2	115	LW-FS-26U-07
32U	1485,9	115	LW-FS-32U-07
36U	1663,7	115	LW-FS-36U-07
38U	1752,2	115	LW-FS-38U-07
42U	1930,0	115	LW-FS-42U-07
48U	2196,7	115	LW-FS-48U-07

Perforated Curved Door

Material: 1.5mm steel **Finish:** Electrostatic powder paint
Colors: RAL 7035 and RAL 9005

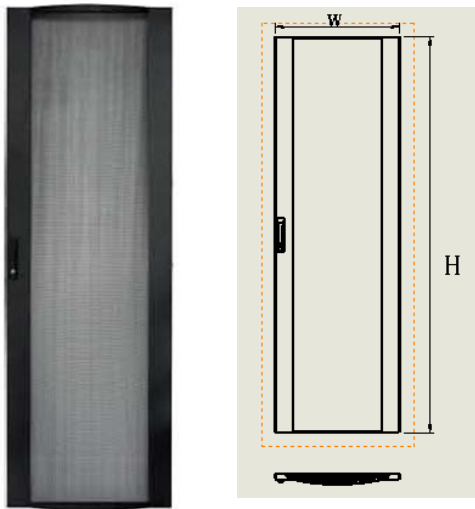

Height (U)	W (mm)	H (mm)	Part No (round hole)	Part No (hexagon. hole)
26U	598	1198,8	LW-FS-26U6-8A	LW-FS-26U6-8B
26U	798	1198,8	LW-FS-26U8-8A	LW-FS-26U8-8B
32U	598	1465,5	LW-FS-32U6-8A	LW-FS-32U6-8B
32U	798	1465,5	LW-FS-32U8-8A	LW-FS-32U8-8B
36U	598	1643,3	LW-FS-36U6-8A	LW-FS-36U6-8B
36U	798	1643,3	LW-FS-36U8-8A	LW-FS-36U8-8B
38U	598	1732,2	LW-FS-38U6-8A	LW-FS-38U6-8B
38U	798	1732,2	LW-FS-38U8-8A	LW-FS-38U8-8B
42U	598	1910,0	LW-FS-42U6-8A	LW-FS-42U6-8B
42U	798	1910,0	LW-FS-42U8-8A	LW-FS-42U8-8B
48U	598	2176,7	LW-FS-48U6-8A	LW-FS-48U6-8B
48U	798	2176,7	LW-FS-48U8-8A	LW-FS-48U8-8B
42U	748	1910,0	LW-FS-48U75-8A	LW-FS-48U75-8B

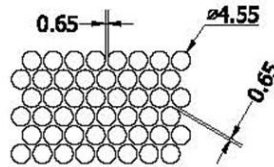

Round hole pattern perforation with 70%

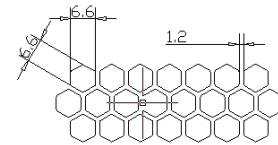

Hexagonal hole pattern perforation with 71%

M-type Perforated Curved Door

Material: 1.5mm steel **Finish:** Electrostatic powder paint
Colors: RAL 7035 and RAL 9005

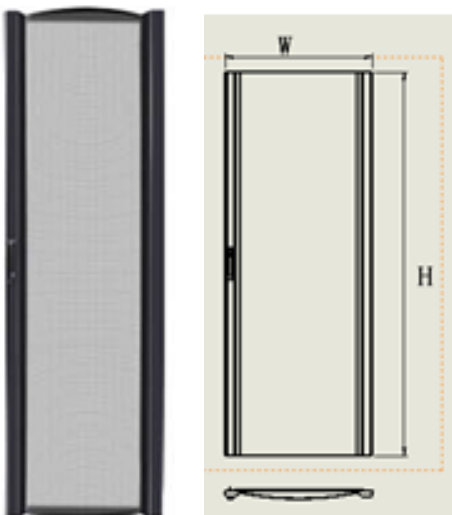

Height (U)	W (mm)	H (mm)	Part No (round hole)	Part No (hexagon. hole)
26U	598	1198,8	LW-FS-26U6-9A	LW-FS-26U6-9B
26U	798	1198,8	LW-FS-26U8-9A	LW-FS-26U8-9B
32U	598	1465,5	LW-FS-32U6-9A	LW-FS-32U6-9B
32U	798	1465,5	LW-FS-32U8-9A	LW-FS-32U8-9B
36U	598	1643,3	LW-FS-36U6-9A	LW-FS-36U6-9B
36U	798	1643,3	LW-FS-36U8-9A	LW-FS-36U8-9B
38U	598	1732,2	LW-FS-38U6-9A	LW-FS-38U6-9B
38U	798	1732,2	LW-FS-38U8-9A	LW-FS-38U8-9B
42U	598	1910,0	LW-FS-42U6-9A	LW-FS-42U6-9B
42U	798	1910,0	LW-FS-42U8-9A	LW-FS-42U8-9B
48U	598	2176,7	LW-FS-48U6-9A	LW-FS-48U6-9B
48U	798	2176,7	LW-FS-48U8-9A	LW-FS-48U8-9B
42U	748	1910,0	LW-FS-48U75-9A	LW-FS-48U75-9B

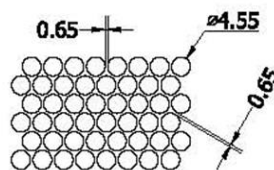

Round hole pattern perforation with 70%

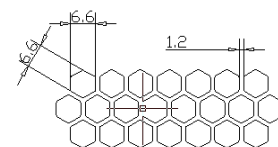

Hexagonal hole pattern perforation with 71%

Perforated Double Flat Door

Material: 1.5mm steel **Finish:** Electrostatic powder paint

Colors: RAL 7035 and RAL 9005



Height (U)	W (mm)	H (mm)	Part No (round hole)	Part No (hexagon. hole)
26U	598	1198,8	LW-FS-26U6-10A	LW-FS-26U6-10B
26U	798	1198,8	LW-FS-26U8-10A	LW-FS-26U8-10B
32U	598	1465,5	LW-FS-32U6-10A	LW-FS-32U6-10B
32U	798	1465,5	LW-FS-32U8-10A	LW-FS-32U8-10B
36U	598	1643,3	LW-FS-36U6-10A	LW-FS-36U6-10B
36U	798	1643,3	LW-FS-36U8-10A	LW-FS-36U8-10B
38U	598	1732,2	LW-FS-38U6-10A	LW-FS-38U6-10B
38U	798	1732,2	LW-FS-38U8-10A	LW-FS-38U8-10B
42U	598	1910,0	LW-FS-42U6-10A	LW-FS-42U6-10B
42U	798	1910,0	LW-FS-42U8-10A	LW-FS-42U8-10B
48U	598	2176,7	LW-FS-48U6-10A	LW-FS-48U6-10B
48U	798	2176,7	LW-FS-48U8-10A	LW-FS-48U8-10B
42U	748	1910,0	LW-FS-48U75-10A	LW-FS-48U75-10B

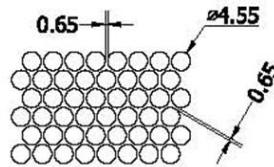

Round hole pattern
perforation with 70%

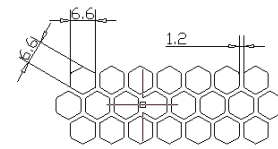

Hexagonal hole pattern
perforation with 71%

Perforated Flat Door

Material: 1.5mm steel **Finish:** Electrostatic powder paint

Colors: RAL 7035 and RAL 9005



Height (U)	W (mm)	H (mm)	Part No (round hole)	Part No (hexagon. hole)
26U	598	1198,8	LW-FS-26U6-11A	LW-FS-26U6-11B
26U	798	1198,8	LW-FS-26U8-11A	LW-FS-26U8-11B
32U	598	1465,5	LW-FS-32U6-11A	LW-FS-32U6-11B
32U	798	1465,5	LW-FS-32U8-11A	LW-FS-32U8-11B
36U	598	1643,3	LW-FS-36U6-11A	LW-FS-36U6-11B
36U	798	1643,3	LW-FS-36U8-11A	LW-FS-36U8-11B
38U	598	1732,2	LW-FS-38U6-11A	LW-FS-38U6-11B
38U	798	1732,2	LW-FS-38U8-11A	LW-FS-38U8-11B
42U	598	1910,0	LW-FS-42U6-11A	LW-FS-42U6-11B
42U	798	1910,0	LW-FS-42U8-11A	LW-FS-42U8-11B
48U	598	2176,7	LW-FS-48U6-11A	LW-FS-48U6-11B
48U	798	2176,7	LW-FS-48U8-11A	LW-FS-48U8-11B
42U	748	1910,0	LW-FS-48U75-11A	LW-FS-48U75-11B

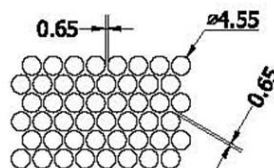

Round hole pattern
perforation with 70%

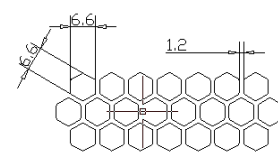

Hexagonal hole pattern
perforation with 71%

Glass Door Supported By Metal Brackets

Material: 1.5mm steel – 5mm Glass

Finish: Electrostatic powder paint

Colors: RAL 7035 and RAL 9005

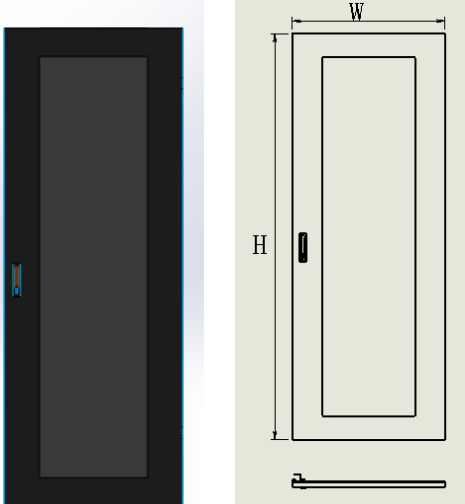

Height (U)	W (mm)	H (mm)	Part No (round hole)
26U	598	1198,8	LW-FS-26U6-12
26U	798	1198,8	LW-FS-26U8-12
32U	598	1465,5	LW-FS-32U6-12
32U	798	1465,5	LW-FS-32U8-12
36U	598	1643,3	LW-FS-36U6-12
36U	798	1643,3	LW-FS-36U8-12
38U	598	1732,2	LW-FS-38U6-12
38U	798	1732,2	LW-FS-38U8-12
42U	598	1910,0	LW-FS-42U6-12
42U	798	1910,0	LW-FS-42U8-12
48U	598	2176,7	LW-FS-48U6-12
48U	798	2176,7	LW-FS-48U8-12
42U	748	1910,0	LW-FS-48U75-12

Adjustable Feet

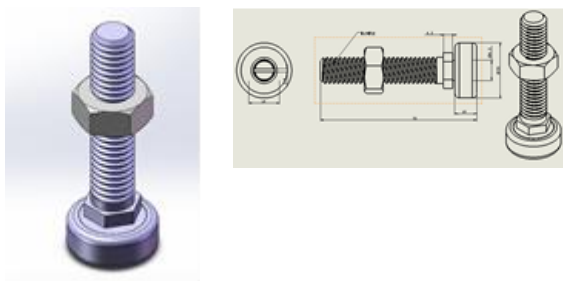

Door Lock

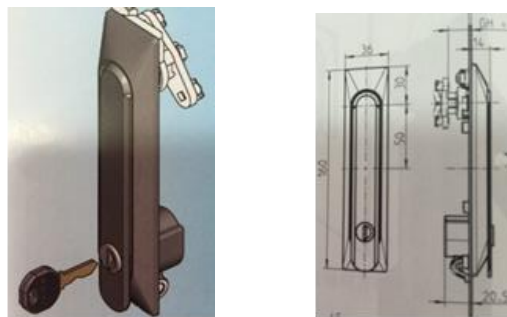

Castor

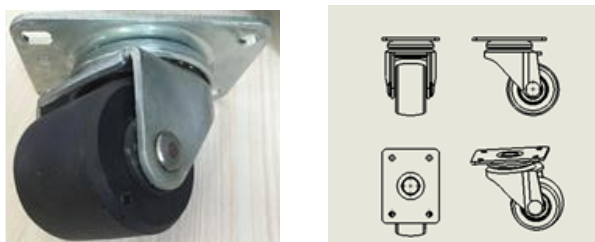

Side Door Lock

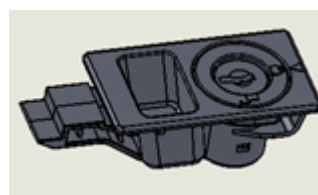

Copyright © 2016 Shanghai Fu Shan Precision Manufacturing Co., Ltd. All Rights Reserved

FUSHAN is a registered trademark of Shanghai Fu Shan Precision Manufacturing Co., Ltd

Notice: This document is for informational purposes only and does not set forth any warranty, expressed or implied, concerning any equipment, equipment feature, or service offered or to be offered by FUSHAN. FUSHAN reserves the right to make changes to this document at any time, without notice, and assumes no responsibility for its use. This informational document describes features that may not be currently available. Contact a FUSHAN sales office for information on feature and product availability. Export of technical data contained in this document may require an export license from the P. R. China Government.

The authors and Shanghai Fu Shan Precision Manufacturing Co., Ltd. shall have no liability or responsibility to any person or entity with respect to any loss, cost, liability, or damages arising from the information contained in this document.

Fushan Europe NV

Fushan Europe NV
Eikenenweg 42,
B-3520 Zonhoven, Belgium